

NPN Silicon Epitaxial Planar Digital Transistor

Features

- With built-in bias resistors
- Simplify circuit design
- Reduce a quantity of parts and manufacturing process

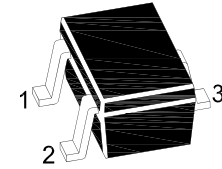
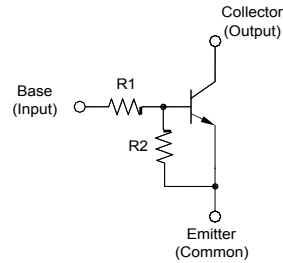

1.Base 2.Emlltter 3.Collector
SOT-523 Plastic Package

Absolute Maximum Ratings ($T_a = 25\text{ }^\circ\text{C}$)

Parameter	Symbol	Value	Unit
Collector Emitter Voltage	V_{CEO}	50	V
Input Voltage	V_I	- 6 to + 40	V
Collector Current	I_C	100	mA
Power Dissipation	P_{tot}	150	mW
Junction Temperature	T_j	150	$^\circ\text{C}$
Storage Temperature Range	T_{stg}	- 55 to + 150	$^\circ\text{C}$

Characteristics at $T_a = 25\text{ }^\circ\text{C}$

Parameter	Symbol	Min.	Typ.	Max.	Unit
DC Current Gain at $V_{CE} = 5\text{ V}$, $I_C = 5\text{ mA}$	h_{FE}	68	-	-	-
Collector Base Cutoff Current at $V_{CB} = 50\text{ V}$	I_{CBO}	-	-	0.5	μA
Emitter Base Cutoff Current at $V_{EB} = 5\text{ V}$	I_{EBO}	-	-	0.88	mA
Collector Emitter Saturation Voltage at $I_C = 5\text{ mA}$, $I_B = 0.25\text{ mA}$	$V_{CE(sat)}$	-	-	0.3	V
Input on Voltage at $V_{CE} = 0.3\text{ V}$, $I_C = 1\text{ mA}$	$V_{I(on)}$	-	-	1.4	V
Input off Voltage at $V_{CE} = 5\text{ V}$, $I_C = 100\text{ }\mu\text{A}$	$V_{I(off)}$	0.3	-	-	V
Transition frequency at $V_{CE} = 10\text{ V}$, $-I_E = 5\text{ mA}$, $f = 100\text{ MHz}$	f_T	-	250	-	MHz
Input Resistance	R_1	7	10	13	K Ω
Resistance Ratio	R_2 / R_1	3.7	4.7	5.7	-

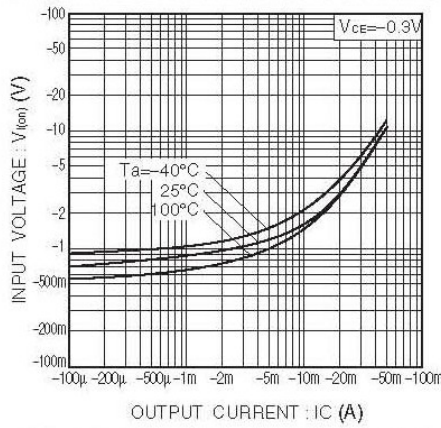

Fig.1 Input voltage vs. output current (ON characteristics)

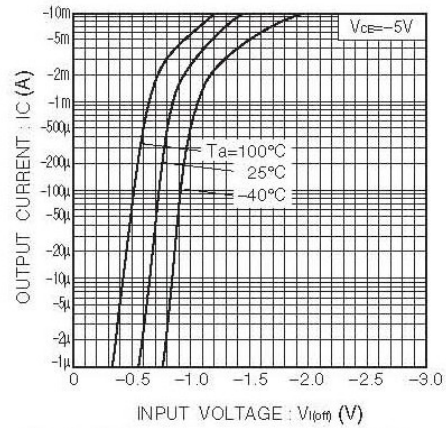

Fig.2 Output current vs. input voltage (OFF characteristics)

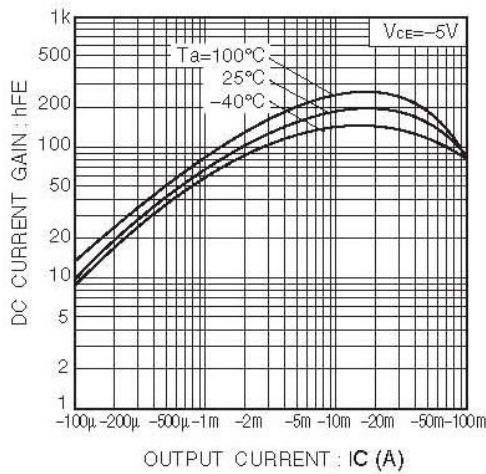

Fig.3 DC current gain vs. output current

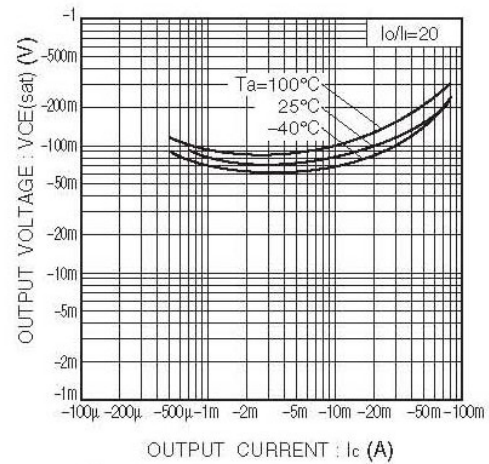
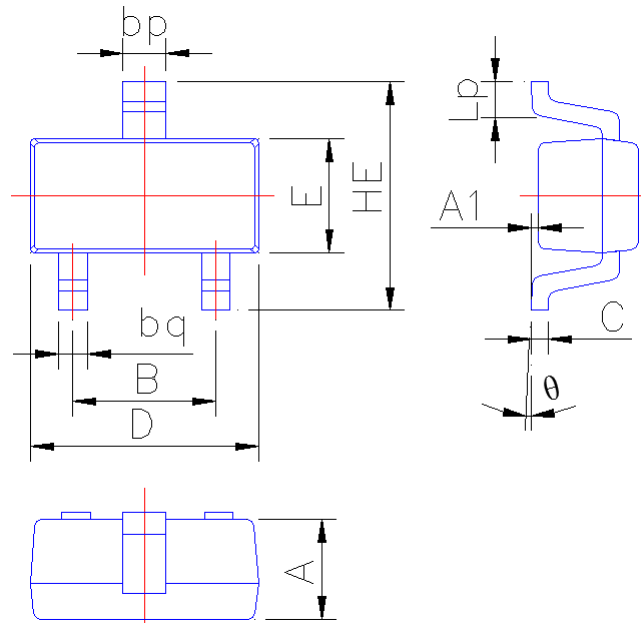

Fig.4 Output voltage vs. output current

PACKAGE OUTLINE

Plastic surface mounted package; 3 leads

SOT-523



Symbol	Dimension in Millimeters	
	Min	Max
A	0.60	0.80
A1	0.010	0.100
B	0.95	1.05
bp	0.26	0.40
bq	0.16	0.30
C	0.09	0.15
D	1.50	1.70
E	0.70	0.85
HE	1.45	1.75
Lp	0.16	0.36
θ	0°	5°